

# *Growing* Strawberries



*in the Inland Northwest*



*Intermountain West*

by Danny L. Barney

## **The author**

*Danny L. Barney*, Extension Horticulture Specialist and Superintendent of the University of Idaho's Sandpoint Research & Extension Center.

## *Contents*

Selecting a site .....	1
Preparing your site .....	3
Selecting cultivars.....	4
Planting, training, and first-year care.....	8
Planting .....	8
Training .....	10
First-year care .....	11
Yearly care .....	11
Irrigation and fertilization .....	11
Weed control .....	13
Managing pests and diseases.....	14
Pests .....	14
Diseases .....	18
Harvesting and storing your strawberries .....	22
Renovating June-bearing strawberries .....	23
Protecting strawberry plants in winter .....	24



*Here is a crop beautifully suited  
to the Inland Northwest and well into Idaho's  
bordering regions in Montana, Wyoming, and Utah.*



# Growing Strawberries

*in the Inland Northwest & Intermountain West*

*Strawberries*, one of the most adaptable fruit crops in the world, are grown from the tropics to near the Arctic Circle. Perennial favorites of home gardeners, they are also grown for local commercial sales throughout the Inland Northwest and Intermountain West. Besides their popularity as fresh fruits, strawberries are used to create pastries, jams, syrups, compotes, fruit leathers, and other food products.

Strawberries are among the easiest fruits to raise. For home production, strawberries are often grown in raised beds, pyramids, decorative pots, and hanging baskets. Commercially, strawberries are grown in flat or raised beds, often in rotation with vegetable crops. Strawberries are an excellent specialty crop for local markets. For more information on the commercial potential for locally-grown strawberries, refer to the readings list at the end of this publication.

## *Selecting a site*

Although strawberries are highly adaptable, good site selection is critical. Strawberries require full sun for consistent production of high-quality fruit.

Many strawberry cultivars (cultivated varieties) are susceptible to *Verticillium* wilt. This fungal disease can persist in the soil for many years, even in the absence of susceptible hosts. *Verticillium* is common on potatoes, tomatoes,



eggplants, raspberries, blackberries, currants, gooseberries, cherries and other stone fruits, and chrysanthemums. If possible, avoid planting strawberries where these crops have been grown within the past five years, and select strawberry cultivars that are resistant to Verticillium wilt.

Lawns and other sodded areas can be infested with grubs that damage strawberries. When planting into an area that has been sodded, cultivate the planting area and grow a rotation or green manure crop other than grass for one year before planting strawberries.



*Strawberries require full sun  
for consistent production of  
high-quality fruit.*



Strawberries are adaptable to a wide range of soil types. They perform best on well drained, sandy loams at least 12 inches deep, but most loam soils provide good results if drainage is adequate. Heavy soils encourage the development of root diseases. Strawberries are shallow-rooted, with most of the roots in the top 12 inches of soil. Cultivars used for fruit production do not tolerate droughty soils without ample irrigation. Soils with pH values between 5.5 and 7.0 provide the best growth.

One way to ensure soil drainage and reduce frost problems is to plant on a site that lies above surrounding areas. Planting sites with slopes of about 2 percent provide drainage without greatly increasing soil erosion.

Raised beds or ridges will improve soil drainage on flat sites. Raised beds can be as simple as mounds of soil or may be enclosed in untreated landscape timbers or stones in an ornamental setting. For home production, raised beds allow you to customize the soil with compost, peat moss,



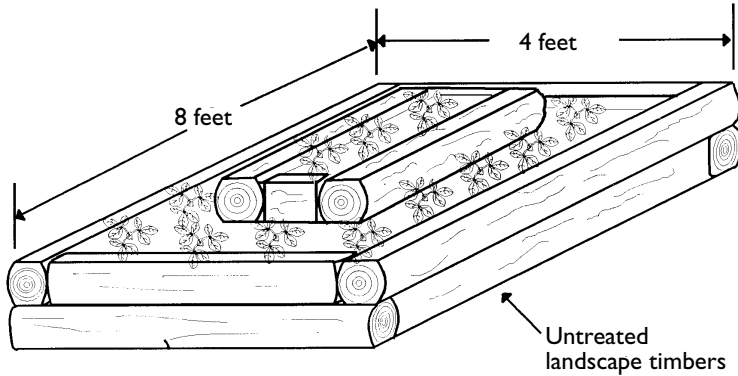

**Figure 1. Typical two-level raised bed for growing strawberries in a home garden.** The two-level system increases light exposure compared with single-level beds and makes managing the rows easier.

sand, or other amendments (fig. 1). Raised beds warm up and dry out quickly in the spring, giving an early start on the season. Tractor-mounted implements are used to create planting ridges for commercial fields (fig. 2).

### *Preparing your site*

Eliminating weeds before planting strawberries is critically important because eradicating weeds in an established strawberry bed is very difficult. Quackgrass and other perennial weeds that spread by underground stems (rhizomes) are highly invasive and are the most serious weeds in strawberries. Growing rotation or green manure crops and mechanically cultivating the soil before planting strawberries are standard weed control practices. Perennial weeds can also be killed before planting strawberries by applying a translocatable herbicide, such as glyphosate, which kills both weed tops and roots.



Pest control is another important preplanting consideration, particularly in a previously sodded site. Some growers incorporate insecticides into soils where sod worms have been a problem. Always follow label directions when applying herbicides and other pesticides.

### *Selecting cultivars*

Choosing strawberry cultivars adapted to your growing area is important in creating a healthy and productive planting. Make sure your selections are cold hardy in your region. Some strawberry cultivars can tolerate winter temperatures near -50°F, while others are killed at temperatures slightly below freezing.

There are three types of strawberries: June-bearing, double-cropping everbearing, and dayneutral. Table 1 lists recommended strawberry cultivars.

*June-bearers.* These are among the most productive and popular strawberries. They form flower buds in the fall and bear one heavy crop the next spring or early summer. The berries ripen over about three weeks, with the earliest berries being the largest. Some cultivars begin ripening three weeks earlier than others. June-bearing cultivars include Benton, Honeyoye, Totem, and many others.

*Double-cropping everbearers.* Everbearers set flower buds during the short days of autumn and again during the long days of midsummer. Consequently, they bear two crops each season, during the spring and late summer. Typically, they produce a few fruits between the main crops. Everbearers are popular because fruit production is spread out over time. Yields, however, are lower than for June-bearing or dayneutral cultivars. Ft. Laramie and Quinault are popular everbearers. Ozark Beauty was once popular, but is being replaced by the better-quality Tristar and Tribute dayneutral cultivars.



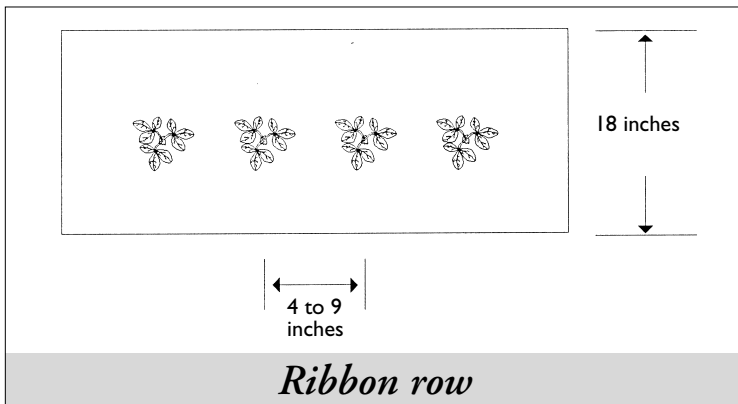
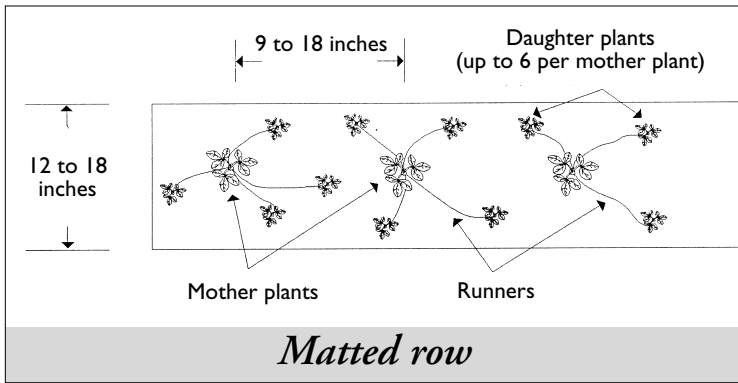
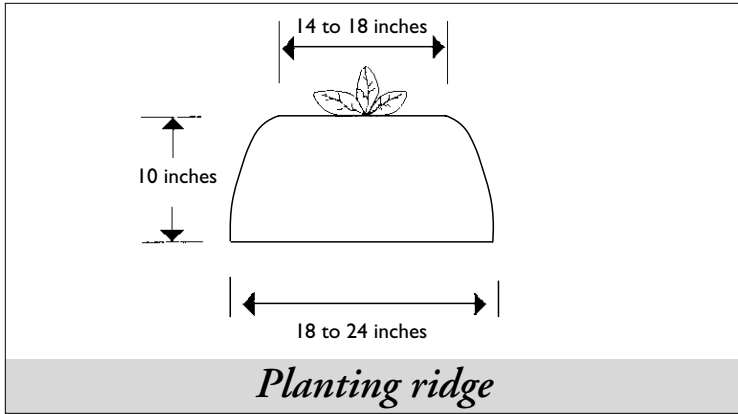

Figure 2. **Strawberry planting systems.**

## *Characteristics and requirements for strawberries*

### **June-bearers**

*Expected yield:* 0.5 to 1.0 pound per foot of row  
during the second and third growing seasons

*Fruiting year:* Second

*Spacing:*

**Matted row:** 12 to 18 inches apart  
in rows 36 to 48 inches apart

**Ribbon row:** 4 to 9 inches apart  
in rows 36 inches apart

### **Double-cropping everbearers**

*Expected yield:* 0.25 to 0.5 pound per foot of row  
during the second and third growing seasons

*Fruiting year:* Second

*Spacing:*

**Matted row:** 12 to 18 inches apart  
in rows 36 to 48 inches apart

**Ribbon row:** 4 to 9 inches apart  
in rows 36 inches apart

### **Dayneutrals**

*Expected yield*

**Year 1:** 0.25 to 0.75 pound per foot of row

**Years 2-3:** 0.5 to 1.5 pounds per foot of row

*Fruiting year:* First

*Spacing:*

**Matted row:** 9 inches apart  
in rows 36 to 48 inches apart

**Ribbon row:** 4 to 9 inches apart  
in rows 36 inches apart



**Table 1. Recommended strawberry cultivars for the Inland Northwest and Intermountain West.**

Cultivar <sup>1</sup>	Berry characteristics					Disease resistance				
	Use <sup>2</sup>	Ripening date <sup>3</sup>	Size <sup>4</sup>	Firmness	Dessert quality <sup>5</sup>	Freezing quality <sup>5</sup>	Leaf scorch <sup>6</sup>	Leaf spot <sup>6</sup>	Red stele <sup>6</sup>	Verticillium wilt <sup>6</sup>
<b>June-bearers</b>										
Earliglow	All	0	S	Firm	E	E	G	P	G	G
Lester	HG	6	L	Firm	E	F	G	G	G	G
Honeye <sup>*</sup>	All	6	L	Firm	G	G	G	G	P	P
Catskill	HG	7	L	Soft	G	F	G	P	P	E
Surecrop	All	7	L	Firm	G	G	F	F	G	E
Cavendish <sup>*</sup>	All	7	VL	Medium	G	G	F	F	G	F
Redchief	PYO	7	L	Firm	E	G	G	G	G	G
Scott	All	8	L	Firm	E	E	G	F	G	F
Allstar	All	8	VL	Firm	E	G	G	G	E	G
Guardian	All	9	L	Firm	G	F	G	F	G	G
Lateglow	All	9	L	Firm	E	E	G	P	G	G
Totem <sup>*</sup>	All	9	L	V. Firm	G	G	U	U	F	F
Glooscap	All	10	L	Firm	G	E	G	G	P	F
Micmac	All	10	M-L	Firm	G	G	G	G	P	P
Benton	All	10	M	Medium	F	G	U	U	U	G
Jewel	All	10	L	V. Firm	E	E	G	G	P	P
Blomidon	All	12	L	Firm	G	E	G	G	P	U
Shuksan	All	12	VL	Firm	G	E	F	P	F	F
<b>Dayneutrals</b>										
Tristar	All	2	M	Firm	E	G	G	P	G	G
Tribute	All	7	M-L	V. Firm	E	G	G	G	E	E
<b>Double-cropping everbearers</b>										
Fort Laramie <sup>*</sup>	HG	4	L	Medium	E	G	U	U	U	U
Quinault	HG	7	M	Soft	G	F	G	G	G	U

<sup>1</sup>\* = Especially cold hardy

<sup>2</sup>All = Suitable for commercial production, U-pick, or home gardens

PYO = Suitable for U-pick or home gardens

HG = Best suited to home gardens

<sup>3</sup>Approximate number of days after Earliglow ripens

<sup>4</sup>Size: S = small; M = medium; L = large; VL = very large

<sup>5</sup>Dessert and freezing quality: P = poor; F = fair; G = good; E = excellent

<sup>6</sup>Disease resistance: P = poor; F = fair; G = good; E = excellent; U = unknown



*Dayneutrals.* These cultivars set flower buds regardless of day length and bear fruit from spring through fall. In many areas, dayneutrals crop similarly to everbearers, with two main crops each year and a trickle of berries in between. Dayneutrals develop few runners, so they are often planted in ribbon rows. Tristar and Tribute are popular with northern growers. Selva, Fern, Seascape, and Hecker are dayneutral cultivars that are popular in other areas of the country, but their hardiness and productivity in the Inland Northwest and Intermountain West are largely untested.

## *Planting, training, and first-year care*

### **Planting**

While it is easy to produce and transplant your own strawberry runner plants, the practice is not always cost effective. Pests and diseases can quickly build up in home and commercial plantings. For best results, buy nursery-grown plants. Consider buying stock certified as virus-indexed, which can yield 50 to 75 percent more fruit than virus-infected plants.

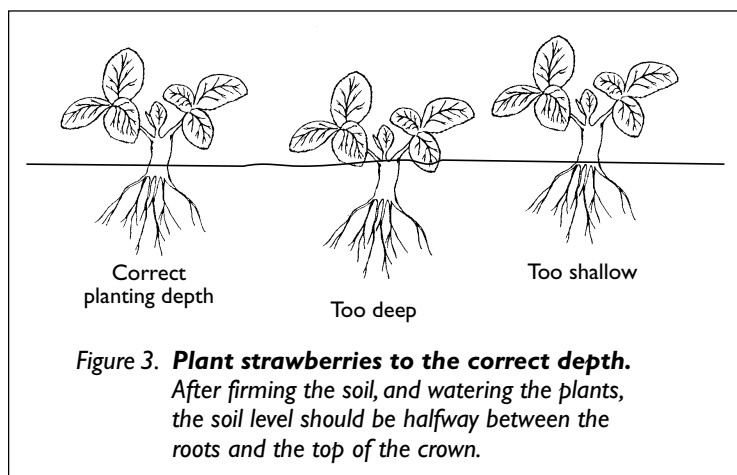

**Figure 3. Plant strawberries to the correct depth.**

*After firming the soil, and watering the plants, the soil level should be halfway between the roots and the top of the crown.*



Dormant strawberry plants (sometimes called crowns) are usually sold bare root in bundles of 25. Place orders with mail order nurseries in late fall or early winter and schedule shipping for early to mid spring. Once the plants arrive, keep them cool and moist, and plant them as soon as possible after nighttime temperatures remain above 25°F. If you cannot plant immediately, keep the plants refrigerated but protected from freezing. If refrigeration is not available, dig a V-shaped trench 6 inches deep, set the strawberries into the trench, cover the roots with soil, and water the plants. Replant into the garden or field as soon as possible.

Garden centers often sell strawberries in containers. Containerized strawberries can be planted spring through fall, but the earlier they are planted, the earlier they will establish. Twenty-five plants will fill 100 square feet of planting beds and produce about 25 quarts of berries during the second and third growing seasons.

When setting dormant strawberry plants into the ground, be careful of the planting depth (fig. 3). Use a hand trowel or dibble to dig a hole large enough to hold the roots vertically without crowding. Avoid spreading the roots horizontally. Firm the plants in by hand. In larger commercial fields, strawberries are usually set into the ground with a tractor-mounted transplanter. Immediately after planting, water the plants well.



*Twenty-five plants will fill 100 square feet of planting beds and produce about 25 quarts of berries during the second and third growing seasons.*



## Training

Strawberries are usually planted in either matted rows or ribbon rows (fig. 2). Matted rows are the easiest and most economical to establish and maintain, and are used by most home and small-scale commercial growers. Ribbon rows are used in intensive cropping systems and can produce high yields in a short time. Ribbon row training is best suited to dayneutral cultivars, which develop few runners. Most growers new to strawberries would be advised to start with a matted row design. Both systems can be used on flat ground, ridges, or in raised beds.

**Matted rows.** To form a matted row, set June-bearing and everbearing plants or crowns (dormant, bare root plants) 12 to 18 inches apart in rows spaced 3 to 4 feet apart. Allow about six runners to develop from each mother plant. Arrange the runners by hand to fill in the rows. When the rows have filled in, clip off new runners that develop and remove runners that extend into the alleys between rows.



Plant dayneutral cultivars about 9 inches apart in rows spaced 3 to 4 feet apart. Go through the plots weekly and remove all runners during the planting year. Allow dayneutral cultivars to form matted rows during the second and third growing seasons.

For all types of strawberries, keep matted rows no more than 12 to 18 inches wide. In rows wider than 18 inches, plants in the middle are unproductive and pest and disease problems increase.

**Ribbon rows.** To create a ribbon row, set the plants 4 to 9 inches apart in rows. Throughout the life of the planting, clip off all runners weekly during the growing season. Some



growers lay drip irrigation lines down the centers of the rows and cover them with black or white plastic film to control weeds. They then burn holes through the plastic and plant the strawberry crowns through the holes. Mulching with clean straw or sawdust helps to control weeds and maintains moisture without creating the disposal problems of plastic mulches.

### **First-year care**

During the year of planting, pinch off all flowers that develop on June-bearing and everbearing strawberries. Removing blossoms the first year helps ensure a healthy and productive stand by encouraging crown, leaf, and root development. Pinch off flowers that develop on dayneutral strawberries until the first of August. These cultivars will continue to set flower buds through the fall and can bear a light first-year crop in areas with long growing seasons. During the first growing season, fertilize the strawberries according to table 2. Do not fertilize at the time of planting.



*For all types of strawberries,  
keep matted rows no more than  
12 to 18 inches wide.*



## *Yearly care*

### **Irrigation and fertilization**

Irrigate strawberries regularly to keep the soil evenly moist but not waterlogged. If possible, place water directly at the base of the plants using drip hoses, hand watering, or irrigation furrows. If you use overhead sprinklers, water early in the morning to allow the foliage and fruit to dry before nightfall. Keeping the plants dry helps reduce disease problems.



**Table 2. Amount of fertilizer to apply to every 10 feet of 18-inch-wide strawberry row.**



	Manure		Commercial fertilizer		
	Cow or horse (pounds)	Poultry or rabbit (pounds)	10-10-10 (ounces)	21-0-0 (ounces)	36-0-0 (ounces)
<b>June-bearers</b>					
<b>Planting year</b>					
4 weeks after planting	8	2	0	0	0
6 weeks after planting	0	0	3	1.5	1
Late August	0	0	3	1.5	1
<b>Second and subsequent years</b>					
April	6 - 12	1.5 - 3	0	0	0
July (after harvest)	0	0	8	4	2.5
<b>Dayneutrals and double-cropping everbearers</b>					
<b>Planting year</b>					
4 weeks after planting	6 - 12	1.5 - 3	0	0	0
Beginning of every month, June through September	0	0	1.5 - 2.5	0.75 - 1.25	0.5 - 0.8
<b>Second and third years</b>					
April	6 - 12	1.5 - 3	0	0	0
Beginning of every month, May through September	0	0	1.5 - 2.5	0.75 - 1.25	0.5 - 0.8

Note: Numerical designations for commercial fertilizers refer to the respective percentages, by weight, of nitrogen (N), phosphorus (P), and potassium (K) in the fertilizer. 21-0-0 is ammonium sulfate. 36-0-0 is ammonium nitrate. Cow and horse manure contain approximately 0.5% nitrogen. Poultry and rabbit manure contain approximately 1.8% nitrogen. Manure releases nutrients slowly. Make only one application of manure each season, applying it 4 weeks after planting and during the April of following years.





Strawberries require fertilization for good production (table 2). Most garden fertilizers work well, but do not use weed-and-feed types that contain herbicides. Ammonium sulfate (21-0-0) is the nitrogen fertilizer of choice on sites with high pH, alkaline soils. Composted manures release nutrients slowly and add organic matter to the soil. Fresh manures, however, can cause salt buildup and damage plants when applied too heavily.

 *If you use overhead sprinklers, water early in the morning to allow the foliage and fruit to dry before nightfall.* 

## Weed control

Weed control is difficult in strawberry plantings, but is absolutely essential for good yields of quality berries. For home gardens, mulching and hand weeding are the methods of choice. They are also used for commercial plantings. Apply 2 to 4 inches of clean straw or sawdust at the time of planting to reduce weed problems. Pack the mulch around and between the plants, but do not cover them. Ensure daughter plants on the runners are in contact with the soil, as they cannot root well through mulches.

Organic mulches are not without their drawbacks. They provide habitats for mice that can damage strawberry plants during the winter. During the summer, slugs thrive under organic mulches. Baits and traps for slugs and mice are recommended if you use organic mulches.

Plastic film is used to control weeds in some commercial strawberry fields and can be used in home gardens. Use nonporous plastic film, not weed-barrier fabrics. Strawberry daughter plants root on top of the porous fabrics, making removal difficult. Black or white films control

weeds better than clear films and do not overheat the soil, as clear films can. Plastic films are used only for ribbon row plantings as they prevent daughter plants from rooting in matted beds.

Fertilizing and irrigating plastic-covered rows create difficulties. Using a drip irrigation line to apply water and fertilizers along the center of the rows under the plastic is usually the easiest and most effective method. Fruit rot problems can be more severe with plastic than with straw mulches. Water puddles on the plastic rather than running through. If the water contains mold spores, raindrops striking the plastic can bounce the spore-contaminated water droplets onto the fruit.

Herbicides are available to control weeds in commercial strawberry fields. Consult with your Cooperative Extension System or pesticide supplier for herbicides registered in your area. Always follow label directions.

### *Managing pests and diseases*

Because pesticide regulations and registrations change frequently, specific pesticide recommendations are not included in this publication. For up-to-date information on materials registered for pests and diseases in your area, contact the Cooperative Extension System office in your county. Always follow label directions.

#### **Pests**

*Aphids.* Shallot and strawberry aphids cause problems for western strawberry growers. These small, pale green to greenish-brown insects are usually found on new shoots and buds in the crowns of the plants and on veins on the undersides of the leaves. Unlike mites,

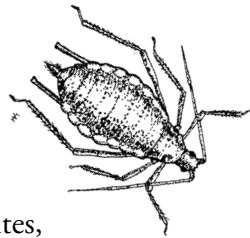

aphids usually remain still while a plant is being examined. Feeding by aphids causes strawberry plants to become stunted with crinkled and curled leaves. Heavy infestations weaken the plants. Aphids also excrete honeydew, upon which sooty mold can grow, making berries inedible. Aphids usually appear in April or May and persist into November. Besides the damage they cause by feeding, aphids can transmit virus diseases. Beneficial insects, such as lady beetles, can help control aphid populations.

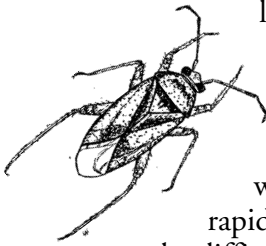

*Lygus bugs.* Several species of insects called lygus bugs or plant bugs attack strawberries. These pests are approximately  $\frac{1}{4}$  inch long, oval, and rather flattened. They are green or brown with reddish-brown markings on their wings. Lygus bugs fly or crawl away rapidly when plants are disturbed and can be difficult to find. They suck out seed contents, causing deformed berries. One to two nymphs (immature bugs) per plant can cause extensive damage.

Controlling weeds near strawberry plantings can help reduce lygus populations. Avoid cutting or otherwise disturbing alfalfa and weeds near your planting before or during the strawberry blossom period. Doing so can force the pests into your strawberries.

*Spittlebugs.* The meadow spittlebug overwinters in the egg stage attached to leaf stems and leaves. Tiny yellow nymphs hatch in April and secrete a white froth over their feeding places on new growth. Nymphs suck juices from leaves and fruit spurs causing these tissues to become distorted and stunted. Injury results in reduced yields and inferior fruit. Spittlebugs are easily controlled with insecticides, or can be washed off plants with a hose.



**Mites.** Both cyclamen and spider mites can seriously damage strawberries. These pests are related to spiders and have eight legs. Cyclamen mites are approximately  $\frac{1}{100}$  inch in diameter, flat, lens-shaped, and transparent. Cyclamen mites feed on young folded leaves in the crown. Damaged leaves emerge stunted, crinkled, and malformed.

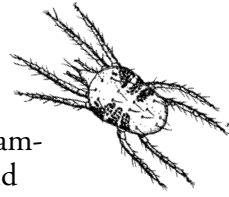

Spider mites are larger, about  $\frac{1}{50}$  inch in diameter, and are found on older leaves. Speckling or bronzing of leaves and the presence of webs and eggs on the undersides of leaves are indications of spider mites.

Pesticides are available for mites, but do not provide complete control. Plant only healthy stock. Inspect plants regularly and avoid destroying beneficial mites and insects by following pesticide label recommendations. Organic growers find insecticidal soaps and predatory mites useful in controlling spider mites. Because of their small size and protected location, cyclamen mites are more difficult to control using organic methods.

**Nematodes.** Several nematodes damage strawberries, including root knot, root lesion, and dagger nematodes. Besides damaging the roots by feeding, some nematodes carry virus diseases that infect strawberries.

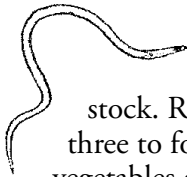

To control nematodes and the viruses they transmit, start with virus-indexed nursery stock. Rotate strawberry beds to a new site every three to four years. Plant rotation crops, such as vegetables or green manures, but do not use red clover, potatoes, tomatoes, or eggplants as rotation crops.

Red clover can harbor a virus-transmitting nematode, while the others can carry Verticillium wilt. Some commercial



strawberry fields are periodically fumigated to kill nematodes and other pests.



*Do not use red clover, potatoes, tomatoes, or eggplants as rotation crops.*



**Leaf tiers.** Omnivorous leaf tiers, also known as strawberry fruitworms, overwinter as tiny, orange larvae in crevices of rough-barked trees and are spread by early spring winds. Mature larvae are  $\frac{3}{4}$  inch long and light cream with tan heads. They web and feed in growing plant tips and in strawberry fruits as they ripen. Unlike closely related leafrollers, omnivorous leaf tiers cause serious damage to plants and fruit. Leaf tiers are common in vetch and wild daisies. They can be controlled with pesticides or picked off plants by hand.

**Root weevils.** Twenty or more species of root weevils attack strawberries. Adult weevils are  $\frac{1}{5}$  to  $\frac{2}{5}$  of an inch long and brown to black. They feed on leaves, causing characteristic notches at the edges of the leaves but little serious damage. Pinkish-white grubs (larvae),  $\frac{1}{4}$  to  $\frac{1}{2}$  inch long, feed on roots and seriously damage or kill strawberry plants. Proper identification of the pest and accurate timing of pesticide applications are critical for successful control. Pesticides and beneficial nematodes are used to control root weevils.

**Slugs and snails.** Slugs and snails thrive under moist conditions and attack the fruits and leaves. They feed most heavily during cloudy days and at night and leave easily detected slime trails. Remove boards, paper, bricks, and other debris that they hide under during the day. Keep strawberry rows no more than 18 inches wide to reduce humidity and improve light penetration.



Do not use organic mulches if slug pressure is heavy. Irrigate early in the day



and avoid sprinkler irrigation, if possible, to keep the foliage dry. Slug baits are commercially available. Shallow containers filled with a mixture of water and brewer's yeast or beer can trap slugs in gardens.



**Birds.** Ripe strawberries are highly attractive to birds, which can cause serious damage to commercial and home crops. Scare devices, such as bright Mylar ribbons, hanging aluminum plates, and rubber snakes are sometimes used to frighten birds away. Birds are highly adaptive, however, and are seldom deterred for long. The most effective method of bird control is to cover the strawberries with bird netting, which is available from garden centers. Anchor the edges of the net to prevent the birds from walking under it.



For small beds, rigid covers can be constructed from chicken wire and wooden frames.

## Diseases

**Gray mold.** *Botrytis*, also known as gray mold, is a fungus that infects ripe and nearly ripe strawberry fruits. Berries infected with *Botrytis* soften and begin to rot, eventually becoming covered with gray mold. The disease is greatly aggravated by wet conditions. Use the plant and row spacings recommended in this publication to encourage rapid drying of the foliage after rain and irrigation. Avoid sprinkler irrigation, if possible, or water early in the day. Pick fruit at least every other day and refrigerate it quickly. Remove rotted fruit from the strawberry rows. Clean straw spread under the plants can reduce infections.



**Leaf scorch.** Leaf scorch is caused by a fungus that overwinters on old, infected leaves. Small, dark-purple, irregular spots form on the upper leaf surfaces. The spots do not develop white centers as with leaf spot disease. When numerous, the spots run together and the leaves appear to be scorched. Infected plants are stunted. During spring rains, spores from a few diseased plants can spread through an entire planting. Cultural practices that limit gray mold also help reduce leaf scorch problems.

**Leaf spot.** Leaf spot is caused by another fungus that survives the winter on old, infected leaves. Dark red or purplish spots form on leaves, gradually becoming grayish or almost white. Fully developed spots are about  $\frac{1}{8}$  inch in diameter, with whitish centers and reddish margins. The spots are scattered widely over the leaf surfaces and interfere with leaf functions. Infections occur during moist weather and are most severe in spring and fall. Follow the cultural practices described for gray mold.

Rake out and remove dead leaves and debris in early spring before new growth starts. Renovating June-bearing strawberries after harvest can reduce leaf spot problems. Fungicides are registered to control leaf spot if the problem becomes severe.

**Powdery mildew.** Powdery mildew causes the edges of infected leaves to curl upward. Leaves are coated with a grayish-white powdery mold and may turn purplish or red. In irrigated fields, the fungus may also attack the fruit. Follow the cultural practices described for gray mold. In small plantings, remove spent leaves when renovating and in early spring.

**Red stele root rot.** Red stele root rot is caused by soilborne fungi (*Phytophthora* species), which may persist in fields for many years. During winter and spring, the cores, or steles, of diseased roots become pinkish-red, gradually turning cinnamon brown and ultimately black. The outer cortex of



the roots remains white. Root symptoms can be difficult to see after May. Infected plants decline, produce little new growth, and may wilt and die. Leaves become bluish-green and lack their normal glossiness.

Root rot is most often found on wet or poorly drained soils. On heavy soils or where drainage is questionable, grow strawberries on ridges, in raised beds, or in containers. Plant clean, high-quality nursery stock. Where space allows, use a chisel plow or subsoiler to break up compacted soil 18 to 20 inches deep between rows in late fall to increase drainage. Fungicides are available to control red stele, but preventative cultural methods are more effective.

***Black root rot.*** Many different fungi, nematodes, and poor soil conditions interact to cause a disorder called black root rot. Symptoms include black discolorations on the roots with the entire root often darkening, becoming unhealthy in appearance, and lacking new growth. Leaves are small, poorly colored, and wilt in hot weather. New growth is sparse and many roots are completely rotted away. Infected roots lack the red core discoloration typical of red stele root rot.

Control black root rot by planting good quality nursery stock on well-drained fertile soil adapted to strawberry production. During planting, handle plants carefully to prevent drying of the roots. Set plants at the proper depth. Rotate your strawberry crop with grasses, grains, or vegetables. Do not plant strawberries on sites with a recent history of black root rot.

***Verticillium wilt.*** *Verticillium* is a fungal pathogen. In strawberries, symptoms include wilting of individual plants, often in patches throughout a planting. Older leaves wilt and tend to curl up along the midvein. Infected plants





become stunted, dry, and flattened with small, yellowish leaves. Brownish streaks occur in the vascular tissue of crown roots or at the base of the petioles.

Avoid planting strawberries where tomatoes, potatoes, peppers, eggplants, melons, cherries, raspberries, blackberries, roses, or chrysanthemums have been grown within the past five years. Select resistant cultivars and plant high-quality, nursery-grown stock. Remove infected plants together with adjacent plants. Do not replant in spots where infections occurred. Keep your planting weed-free. Soil fumigants are often used before planting in large commercial fields to control *Verticillium* and other pests and diseases.

**Viruses.** Tomato ringspot virus is spread by the dagger nematodes and related species. The virus causes stunting and sometimes kills infected plants.

Crinkle, mottle, mild yellow-edge, and vein banding viruses commonly infect strawberry plants. They are transmitted by the strawberry aphid, *Chaetosiphon fragaefolli*. These diseases reduce vigor and yields. Symptoms include dwarfing, leaf cupping, and yellowing. Totem is noted for resistance to aphid-transmitted viruses.

Tobacco streak virus and pallidosis disease infect strawberry fields, but their methods of transmission are not known. Tobacco streak causes loss of vigor and yield without distinctive symptoms. Most popular strawberry cultivars in the Pacific Northwest are susceptible to tobacco streak virus. The pallidosis agent increases the severity of many aphid-borne viruses. To control all viruses, purchase plants certified as virus-indexed, control aphids and nematodes, and avoid setting out new plantings next to old, virus-infected ones.



## *Harvesting and storing your strawberries*

To ensure high fruit quality, harvest berries in early morning after the dew is off the ground. If the berries will be stored more than a few hours, avoid picking on wet days or when berries are wet from irrigation. Discard overripe or damaged fruit. Remove damaged, overripe, and rotted fruit from the rows to reduce fruit rot problems with later berries.



*After picking, cool the berries to 34° to 36°F  
as quickly as possible.*



Pick strawberries by pinching off the stems with your thumb and forefinger, leaving the stem and cap attached to the berry. This method reduces damage to the fruit and increases shelf life.

Harvest at least every two days. Under hot conditions, you may have to pick every day. Collect the fruit in shallow containers. Most commercial growers use half-pint or pint baskets, with twelve baskets held in a wooden or cardboard flat.

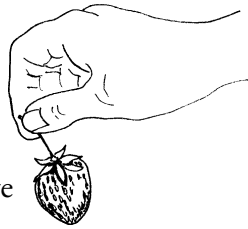

After picking, cool the berries to 34° to 36°F as quickly as possible. Even short delays in cooling the fruit can increase fruit rots and decrease quality. For home use, place dry strawberries into a refrigerator. Do not wash the berries before refrigerating them unless you plan to use the fruit within a few hours. Grower-picked strawberries from large, commercial operations are often cooled by placing them into forced-air tunnels inside walk-in coolers. Advise your



U-pick and farmers' market customers to refrigerate their fruit as quickly as possible to preserve fruit quality.

Picking berries when they are wet or cooling them with water increases fruit rot. Handle the berries as gently and as little as possible.

For freezing, rinse the berries, cut off the caps, and slice the fruit into halves or strips. Freeze the sliced fruit in heavy-duty plastic bags.

Under ideal conditions, fresh strawberries have a shelf life of about seven days. Most commercial growers try to get strawberries to their final consumers within 24 to 48 hours.

## *Renovating June-bearing strawberries*

Fields of June-bearing strawberries can be renovated each year following harvest. This practice helps invigorate the plants and reduces pest and disease problems. Renovation involves removing the leaves, narrowing rows, and fertilizing. Commercial growers often apply herbicides when renovating. Only June-bearing strawberries are renovated. Dayneutral and everbearing strawberries are not.

Renovate one to two weeks after harvest in early to mid July. If runner production has been sparse on cultivars that normally runner heavily, renovate immediately after harvest.

Mowing is the preferred method of removing old foliage. Set the mower low enough to cut off the old leaves, but high enough so as not to damage the crowns.

Removing leaves from the planting can reduce insect and disease damage. Most commercial growers do not remove

leaves, but they do till them into the soil, which also helps to reduce insect and disease problems.

After mowing, use a rototiller or disk to cultivate alleyways and to narrow the rows to their recommended widths (12-18 inches for matted rows). Cultivate in one direction only to avoid dislodging newly rooted runners in matted row systems. Cultivate no more than 2 inches deep to reduce the number of weed seeds you bring to the surface. Be careful not to bury the crowns when cultivating. Fertilize after cultivation (table 2).



*Only June-bearing strawberries  
are renovated.*



### *Protecting strawberry plants in winter*

In late fall, irrigate heavily before the ground freezes, if necessary, to protect against winter desiccation. After several frosts below 28°F, mulch strawberries with 6 to 8 inches of wheat, rye, or barley straw to protect the plants from cold temperatures and drying winds. Use straw that is clean and free of grain and weed seeds. Long pine needles, such as ponderosa pine, also make effective mulches. Avoid using hay because most hays contain weed seeds. Also avoid grass clippings, oat straw, and leaves from deciduous trees, such as maple and oak, which pack down and mold during the winter. In early spring, before strawberries show new growth, rake the mulch into the alleys.







*Gardening publications  
from the University of Idaho*

Strawberry Production: Overview (CIS 931) .....	50¢
Specialty Farming in Idaho: Is It for Me? (EXT 743) .....	\$1.00
Specialty Farming in Idaho: Selecting a Site (EXT 744) ..	\$1.00
Berry Varieties for Idaho (EXT 739) .....	\$2.00
Insects and Mites Destructive to Berries (CIS 628) .....	50¢
Diseases of Raspberries in Idaho (CIS 789) .....	35¢
Selecting Grape Cultivars and Planting Sites in Idaho (CIS 1043) .....	\$1.00
Growing Blueberries in Idaho (BUL 815)	
Growing Raspberries and Blackberries in the Inland Northwest and Intermountain West (BUL 812)	

You can order these publications from the  
University of Idaho Cooperative Extension System office  
in your county or directly from

**Agricultural Publications**  
**University of Idaho**  
**Moscow, ID 83844-2240**

**phone: (208) 885-7982**  
**fax: (208) 885-4648**  
**email: cking@uidaho.edu**

Your payment should include 50¢ postage for the first  
publication and 25¢ for each additional publication. Idaho  
residents add 5% sales tax.

**For other University of Idaho publications,  
check the Resources for Idaho web site at  
<http://info.ag.uidaho.edu>**



## *Market gardeners, home gardeners,*

here is a crop beautifully suited to the Inland Northwest and well into Idaho's bordering regions in Montana, Wyoming, and Utah.

*Growing Strawberries* gives you the information you need to plan, plant, and raise healthy strawberry plantings in a market garden or backyard bed. Learn about cultivars you'll never see in a local supermarket, despite their surpassing flavor. Read about plant and row spacing, fertilization requirements, overwintering practices, and the simple, routine practices that will keep your crop nearly pest free.

Author Danny L. Barney, horticulturist and superintendent at the University of Idaho Sandpoint Research & Extension Center, shares the wisdom he has accumulated in 11 years of rigorously testing dozens of strawberry cultivars and the techniques for growing them.

### *Did you know?*



Just 25 well-tended plants will produce 25 quarts of berries during their second and third growing seasons, enough to satisfy your hankerings for strawberry jam, strawberry shortcake, strawberry pie, and handfuls of fresh strawberries for your breakfast cereal.



By growing a combination of June-bearing, double-cropping, and dayneutral varieties you can enjoy berries all season, from early summer through fall.



Strawberries keep best when refrigerated right after harvest.



University of Idaho  
Cooperative Extension System

Issued in furtherance of cooperative Extension work in agriculture and home economics, Acts of May 8 and June 30, 1914, in cooperation with the U.S. Department of Agriculture, LeRoy D. Luft, Director of Cooperative Extension System, University of Idaho, Moscow, Idaho 83844. The University of Idaho provides equal opportunity in education and employment on the basis of race, color, religion, national origin, gender, age, disability, or status as a Vietnam-era veteran, as required by state and federal laws.